

# QUICK DISCONNECT & SWIVEL COUPLINGS

<b>Product</b>	<b>Page</b>
Overview QC types	416-419
ISO A - ISO B - Trailer Brake	420
Nordic Range - TEMA Interchange	421-422
HQ Flat Face - TEMA IF-Faster 2FFI Interchange	422-423
HS Screw to connect - CCV Faster Interchange	423
LC Screw to connect - 75 Serie Snap Tite Interchange	423
SJ10-SJ90 Swivel joints	424

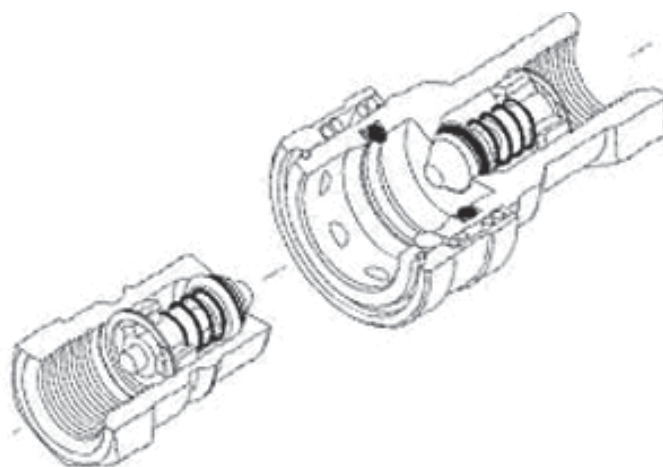

# OVERVIEW QC & SWIVEL COUPLINGS

## ISO A Couplings

### IA Serie ISO A

ISO A couplings made to the ISO 7241:2014 Series A standard



### P Serie ISO A Push-Pull

ISO A push / pull female couplings (Connects with 1/2" ISO A male probes)



### IAPC Serie ISO A with Elimintaor

Connect under pressure ISO A couplings made to the ISO 7241:2014 Series A standard



## General Purpose Couplings

### F Serie Nordic (TEMA)

*Interchange TEMA, Cejn 525*  
Connect under pressure high flow couplings fitted with a safety locking sleeve



### TB Serie Trailer brake

TB trailer brake couplings are used to connect the hydraulic braking system of tractors to trailers. The male coupling is normally panel mounted on the tractor.



### PWC Serie

Free flow, valve less pressure washer couplings



### PLC Serie

*Interchange Faster VV*  
Screw connect and pull break couplings interchangeable with the DIN V series probes



### KM Serie

*Interchange Cejn 115/116*  
High pressure poppet valve couplings



## Flat Face Couplings

### HQ Serie

*Interchange Snap-Tite 74, TEMA IF*  
*Faster 2FFN/2FFI/FFH*  
Flat face couplings made to the ISO 16028 Standard



### HCP Serie

*Interchange Faster 3FFI, Stucchi APM*  
Connect under pressure flat face male couplings made to the ISO 16028 Standard



### H90 Serie

90 degree flat face couplings made to the ISO 16028 Standard



### HP Serie

*Interchange: Stucchi HP, Cejn X65*  
High pressure flat face couplings fitted with a safety locking sleeve



### VP Serie

High pressure (up to 600bar) screw to connect flat face heavy duty couplings



# OVERVIEW QC & SWIVEL COUPLINGS

## Screw To Connect Couplings

### HFT Serie

*Interchange Stucchi VEP, Parker FET*

Screw connect flat face couplings



### TC Serie

*Interchange Faster CVE*

Screw connect tipper couplings



### HS Serie

*Interchange Faster CVV- Stucchi VD*

General purpose screw connect poppet couplings made to the ISO 14541 Standard



### SP Serie

*Interchange Gromelle 6000*

High pressure screw connect couplings



### PSP | PSB Serie

*Interchange Parker 3000, Enerpac C-604*

High pressure screw connect poppet & ball couplings made to the ISO 14540 Standard



### PTC Serie

*Interchange Faster VVS*

High pressure heavy duty screw connect couplings



### S Serie

High flow screw to connect couplings 1/4" - 2.1/2"



### LC Serie

*Interchange Snap-Tite 75*

Heavy duty screw connect couplings



### TLX Serie

TLX is a Flat-Face twist lock coupling for the toughest applications in the construction and demolition segment.



PYPLOK

FLANGES

PIPES & TUBES

CLAMPS

VALVES

BITE TYPE FITTINGS

HP HOSES

QUICK COUPL.

TEST POINTS

ADAPTORS

MACHINES

OTHER PRODUCTS

# OVERVIEW QC & SWIVEL COUPLINGS

## Stainless Steel & Brass Couplings

**HSS Serie SS316**  
*Interchange Faster CVV SS*  
 Stainless steel flat face couplings made to the ISO 16028 Standard dimensions



**PTS Serie SS316**  
*Interchange: Faster VVS SS*  
 Stainless steel high pressure heavy duty screw connect couplings



**IAS Serie ISO A SS316**  
 Stainless steel ISO A couplings made to the ISO 7241:2014 Series A Standard dimensions



**PWS Serie SS316**  
 Stainless steel pressure washer couplings



**IBS Serie ISO B SS316**  
 Stainless steel ISO B couplings made to the ISO 7241:2014 Series B Standard dimensions



**SHS Serie SS316**  
 Stainless steel general purpose screw connect couplings made to the ISO 14541 Standard dimensions



**WSC Serie Brass**  
 Interchange Snap-Tite 78, Faster FB Brass wing style screw to connect with steel nut



**IBB serie ISO B Brass**  
 Brass ISO B couplings made to the ISO 7241:2014 Series B standard dimensions



## Rotary Couplings

**SJ90/ GG90**  
 90 degree rotary couplings



**SJ10/ GGIL**  
 In-line rotary couplings



**SR90 SS316**  
 Stainless steel 90 degree rotary couplings



**SRIL SS316**  
 Stainless steel in-line rotary couplings



## Multiplates

**MP**  
 Multiplate couplings

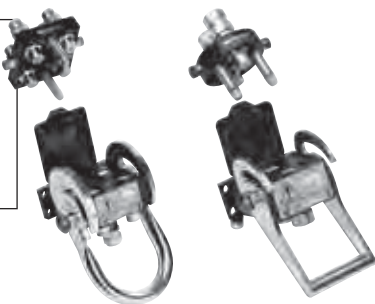
# OVERVIEW QC & SWIVEL COUPLINGS

## BOP Certified Ranges

BOP (Blow Out Preventer) Lloyds approved couplings are designed for use in the Oil & Gas industries and are also certified under API 16D regulations.

**HFT (API)**



**LC (API)**



## Accessories

### Dust Caps & Plugs

Dust Caps and Plugs in a variety of styles and colours



### Seal Kits

Seal Kits available for a variety of coupling Series in a range of seal materials



PYPLOK

FLANGES

PIPES & TUBES

CLAMPS

VALVES

BITE TYPE FITTINGS

HP HOSES

QUICK COUPL.

TEST POINTS

ADAPTORS

MACHINES

OTHER PRODUCTS

# QUICK DISCONNECT COUPLINGS

## IA Serie ISO A Male



Pro .no	BSP	WP Bar	BP Bar	Material
ISO HAN 1/4	1/4	400	2200	
ISO HAN 3/8	3/8	350	1800	
ISO HAN 1/2	1/2	320	1500	Carbon steel with trivalent plating (Zinc nickel plating available)
ISO HAN 3/4	3/4	300	1300	
ISO HAN 1	1	250	1200	
ISO HAN 1.1/4	1 1/4	250	1200	
ISO HAN 1.1/2	1 1/2	230	1000	
ISO HAN 2	2	170	800	

## IA Serie ISO A Female



Pro .no	BSP	WP Bar	BP Bar	Material
ISO HUN 1/4	1/4	400	2200	
ISO HUN 3/8	3/8	350	1800	
ISO HUN 1/2	1/2	320	1500	Carbon steel with trivalent plating (Zinc nickel plating available)
ISO HUN 3/4	3/4	300	1300	
ISO HUN 1	1	250	1200	
ISO HUN 1.1/4	1 1/4	250	1200	
ISO HUN 1.1/2	1 1/2	230	1000	
ISO HUN 2	2	170	800	

## P Serie ISO A Female Push Pull



Pro .no	BSP	WP Bar	BP Bar	Material
ISO HUN 1/2 PUSH	1/2	250	1000	Carbon steel with trivalent plating (Zinc nickel plating available)

## IAPC Serie ISO A Male

Male coupler w/eliminator, BSP



Prod.no	Thread BSP	WP Bar	BP Bar	Material
ISO HAN 1/2 w/eliminator	1/2	250	1500	Carbon steel with trivalent plating (Zinc nickel plating available)

## IAPC Serie ISO A Female

Female coupler w/elimintaor, BSP



Prod.no	Thread BSP	WP Bar	BP Bar	Material
ISO HUN 1/2 w/elimintaor	1/2	320	1500	Carbon steel with trivalent plating (Zinc nickel plating available)

## TB Serie ISO 5676

Trailer Brake

Female - Male Coupler BSP



Prod.no	Thread BSP	WP Bar	BP Bar	Material
TB-08F	1/2	220	900	Carbon steel with trivalent plating
Prod.no	Thread BSP	WP Bar	BP Bar	Material
TB-08M	1/2	220	900	Carbon steel with trivalent plating

# QUICK DISCONNECT COUPLINGS

## NORDIC Serie F

### Male coupler w/eliminator

BSP, Zinc Nickel coated  
Interchange TEMA -Cejn Nordic



Prod.no	Thread BSP	WP Bar	BP Coupled Bar	Material
Nordic F-serie 3/8" Male	3/8	350	1500	Carbon Steel with Zinc-
Nordic F-serie 1/2" Male	1/2	315	1300	Nickel plating (1200 hours
Nordic F-serie 3/4" Male	3/4	300	1250	with no red rust in salt
Nordic F-serie1" Male	1	260	1100	spray tests)

## NORDIC Serie F

### Female coupler w/eliminator

BSP, Zinc Nickel coated  
Interchange TEMA -Cejn Nordic



Prod.no	Thread BSP	WP Bar	BP Coupled Bar	Material
Nordic F-serie 3/8" Female	3/8	350	1500	Carbon Steel with Zinc-
Nordic F-serie 1/2" Female	1/2	315	1300	Nickel plating (1200 hours
Nordic F-serie 3/4" Female	3/4	300	1250	with no red rust in salt
Nordic F-serie1" Female	1	260	1100	spray tests)

## NORDIC Serie 525

### Male standard coupler

BSP, Zinc Nickel coated  
Interchange TEMA -Cejn Nordic



Prod.no	Thread BSP	WP Bar	BP Coupled Bar	Material
Nordic 525 1/4" Male	1/4	450	1800	Carbon Steel with Zinc-
Nordic 525 3/8" Male	3/8	350	1500	Nickel plating (1200 hours
Nordic 525 1/2" Male	1/2	315	1300	with no red rust in salt spray
Nordic 525 3/4" Male	3/4	300	1250	tests)
Nordic 525 1" Male	1	260	1100	

## NORDIC Serie 525

### Female standard coupler

BSP, Zinc Nickel coated  
Interchange TEMA -Cejn Nordic



Prod.no	Thread BSP	WP Bar	BP Coupled Bar	Material
Nordic 525 1/4" Female	1/4	450	1800	Carbon Steel with Zinc-
Nordic 525 3/8" Female	3/8	350	1500	Nickel plating (1200 hours
Nordic 525 1/2" Female	1/2	315	1300	with no red rust in salt spray
Nordic 525 3/4" Female	3/4	300	1250	tests)
Nordic 525 1" Female	1	260	1100	

## NORDIC Serie 525

### Male Coupler Without Valve

BSP, Zinc Nickel coated  
Interchange TEMA -Ce n Nor ic



Prod.no	Thread	WP Bar	BP Coupled Bar	Material
1219299	1/4	450	1800	Carbon Steel with Zinc-Nickel
1219289	3/8	350	1300	plating (1200 hours with no red
1219303	1/2	300	1100	rust in salt spray tests)

## NORDIC Serie 525

### Female Coupler Without Valve

BSP, Zinc Nickel coated  
Interchange TEMA -Ce n Nor ic



Prod.no	Thread	WP Bar	BP Coupled Bar	Material
1219301	1/4	450	1800	Carbon Steel with Zinc-Nickel
1219292	3/8	350	1300	plating (1200 hours with no red
1219306	1/2	300	1100	rust in salt spray tests)

# QUICK DISCONNECT COUPLINGS

## NORDIC Serie SS316

Male Coupler, BSP, Stainless Steel  
Interchange TEMA -Cejn Nordic



Prod.no	Thread	WP Bar	BP Coupled Bar	Material
Nordic 1/4-316 Male	1/4	250	1000	AISI 316
Nordic 3/8-316 Male	3/8	300	1200	
Nordic 1/2-316 Male	1/2	300	1000	stainless steel
Nordic 3/4-316 Male	3/4	200	1000	
Nordic 1-316 Male	1	200	800	

## NORDIC Serie SS316

Female Coupler, BSP, Stainless Steel  
Interchange TEMA -Cejn Nordic



Prod.no	Thread	WP Bar	BP Coupled Bar	Material
Nordic 1/4-316 Female	1/4	250	1000	AISI 316
Nordic 3/8-316 Female	3/8	300	1200	
Nordic 1/2-316 Female	1/2	300	1000	stainless steel
Nordic 3/4-316 Female	3/4	200	1000	
Nordic 1-316 Female	1	200	800	

## HQ FLAT FACE ISO

**16028** Male Coupler BSP  
Interchange TEMA IF, Faster 2FFI, ++



Prod.no	Thread	WP Bar	BP Bar	BP Bar Coupled	Material
HQ06M-04	1/4	400	1220	1700	
HQ10M-06	3/8	350	1050	1500	
HQ10M-08	1/2	350	1050	1500	Carbon steel with zinc nickel plating (1200 hours with no red rust in salt spray tests)
HQ12M-08	1/2	350	1000	1200	
HQ12M-12	3/4	350	1000	1200	
HQ16M-12	3/4	350	1100	1200	
HQ19M-16	1	350	1100	1450	
HQ25M-20	1 1/4	260	800	800	
HQ32M-24	1 1/2	250	1200	1100	
HQ40M-32	2	250	1000	1000	

## HQ FLAT FACE ISO

**16028** Female Coupler BSP  
Interchange TEMA IF, Faster 2FFI, ++



Prod.no	Thread	WP Bar	BP Bar	BP Bar Coupled	Material
HQ06F-04	1/4	400	1500	1700	
HQ10F-06	3/8	350	1100	1500	
HQ10F-08	1/2	350	1100	1500	Carbon steel with zinc nickel plating (1200 hours with no red rust in salt spray tests)
HC12F-08	1/2	350	1050	1200	
HQ12F-12	3/4	350	1050	1200	
HQ16F-12	3/4	350	1100	1200	
HQ19F-16	1	350	1050	1450	
HQ25F-20	1 1/4	260	800	800	
HQ32F-24	1 1/2	250	1200	1100	
HQ40F-32	2	250	1000	1000	

## HCP FLAT FACE ISO 16028

**Connect under pressure**  
Male Coupler BSP  
Interchange TEMA IF, Faster 2FFI, ++



Prod.no	Thread	WP Bar	BP Bar	BP Bar Coupled	Material
HCP10M-06	3/8	350	1500	1500	
HCP10M-08	1/2	350	1500	1500	Carbon steel with zinc nickel plating (1200 hours with no red rust in salt spray tests)
HCP12M-08	1/2	350	1500	1200	
HCP12M-12	3/4	350	1500	1200	
HCP19M-16	1	350	1600	1450	



# QUICK DISCONNECT COUPLINGS

## H90 FLAT FACE 90° ISO 16028

H90 is designed for use in applications that require a 90° elbow in the hydraulic circuit, such as digger booms. The right angle design allows for easy mounting without the need for additional fittings, reducing potential leakage paths and cost.



Prod.no	Thread	WP Bar	BP Bar	BP Bar Coupled	Material
H9012M-06	9/16-18 JIC Male	350	1050	1050	Carbon steel with zinc nickel plating (1200 hours with no red rust in salt spray tests)
H9012M-08	1/2" SAE Female	350	1050	1050	
H9012M-12	1 1/16-12 JIC Male	350	1050	1050	

## HS screw connect poppet

### ISO 14521

Male Coupler BSP  
Interchange FASTER CCV, STUCCHI VD



Male Coupler also with NPT, UNF,  
DIN 3861 L-S serie and SAE flange

Prod.no	Front end Thread	Thread BSP fem.	WP Bar	BP Bar Coupled	Material
HS04-1-IGF04	M24x2	1/4	450	1800	Carbon steel with zinc nickel or trivalent plating
HS08-1-IGF04	M28x2	1/4	450	1600	
HS08-1-IGF06	M28x2	3/8	450	1600	
HS10-1-IGF06	M36x2	3/8	450	1600	AISI 316 Stainless steel <b>SHS serie</b>
HS10-1-IGF08	M36x2	1/2	450	1600	
HS12-1-IGF08	M42x2	1/2	400	1500	
HS12-1-IGF12	M42x2	3/4	400	1500	AISI 316 Stainless steel <b>SHS serie</b>
HS20-1-IGF12	M48x3	3/4	300	1180	
HS20-1-IGF16	M48x3	1	300	1180	
HS25-1-IGF16	M70x3	1	300	1180	AISI 316 Stainless steel <b>SHS serie</b>
HS25-1-IGF20	M70x3	1.1/4	300	1180	

## HS screw connect poppet ISO 14521

Female Coupler BSP  
Interchange FASTER CCV, STUCCHI VD



Female Coupler also with NPT, UNF,  
DIN 3861 L-S serie and SAE flange

Prod.no	Front end Thread	Thread BSP fem.	WP Bar	BP Bar Coupled	Material
HS04-2-IGF04	M24x2	1/4	450	1800	Carbon steel with zinc nickel or trivalent plating
HS08-1-IGF04	M28x2	1/4	450	1600	
HS08-1-IGF06	M28x2	3/8	450	1600	
HS10-1-IGF06	M36x2	3/8	450	1600	AISI 316 Stainless steel <b>SHS serie</b>
HS10-1-IGF08	M36x2	1/2	450	1600	
HS12-1-IGF08	M42x2	1/2	400	1500	
HS12-1-IGF12	M42x2	3/4	400	1500	AISI 316 Stainless steel <b>SHS serie</b>
HS20-1-IGF12	M48x3	3/4	300	1180	
HS20-1-IGF16	M48x3	1	300	1180	
HS25-1-IGF16	M70x3	1	300	1180	AISI 316 Stainless steel <b>SHS serie</b>
HS25-1-IGF20	M70x3	1.1/4	300	1180	

# QUICK DISCONNECT & SWIVEL COUPLINGS

## LC-Serie

Interchange Snap-Tite 75-Serie



LC-Serie for heavy duty applications where high pressure or pressure impulses are present.  
An API Certified version is available in sizes 19-25-32 which are Lloyds certified for use in blow out preventer (BOP) applications

Part no.	Thread N=NTP G=BSP	WP Bar	BP Bar	BP Bar Coupled	Specifiaction
<b>Female Coupler</b>					
LC19-F-12 N/G	3/4	345	1380	1380	Carbon steel with triviliant plating Operating temperatures: -40°C to 106°C Dust caps in aluminium
LC25-F-16 N/G	1	345	1380	1380	
LC32-F-20 N/G	1 1/4	345	1050	1050	
LC40-F-24 N/G	1 1/2	345	1050	1050	
LC50-F-32 N/G	2	345	1050	1050	
<b>Male Coupler</b>					
LC19-M-12 N/G	3/4	345	1380	1380	
LC25-M-16 N/G	1	345	1380	1380	
LC32-M-20 N/G	1 1/4	345	1050	1050	
LC40-M-24 N/G	1 1/2	345	1050	1050	
LC50-M-32 N/G	2	345	1050	1050	

## SJ10 SWIVEL

The series SJ swivel joints are designed to be mounted between a hose assembly and a rigid component in order to allow and compensate occasional rotations, preventing hose damages. The swivel joint rotation is based on one or two rows of radial balls (one row up to size 1/2" included).

1/2"≤

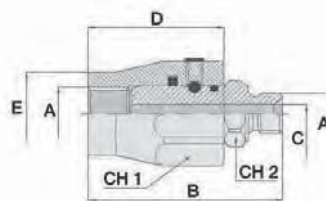

3/4"-

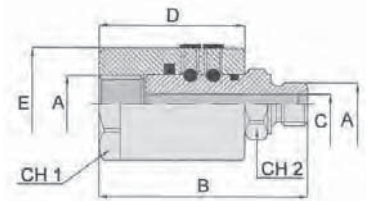

CODE CODICE	Ø A*	B		C		D		Ø E		CH 1		CH 2		MAX PRESSURE IN ROTATION		STATIC MAX PRESSURE	
		mm		mm		mm		mm		mm		mm		bar	psi	bar	psi
SJ10-04	1/4"	61		6		42		24		ES30		ES19		200	2900	400	5800
SJ10-06	3/8"	66		8.5		44		25		ES34		ES24		200	2900	400	5800
SJ10-08	1/2"	71		11.5		47		32		ES36		ES27		150	2175	300	4350
SJ10-12	3/4"	89		15		60		49.5		ES45		CH34		150	2175	300	4350
SJ10-16	1"	98		20		65		54.5		ES50		CH41		100	1450	300	4350
SJ10-20	1.1/4"	101		28		63		60		ES55		CH50		100	1450	300	4350
SJ10-24	1.1/2"	110		35		70		69.5		ES65		CH55		80	1160	300	4350
SJ10-32	2"	119		44		75		84.5		ES75		CH65		50	725	250	3625

## SJ90 90° SWIVEL

1"≤

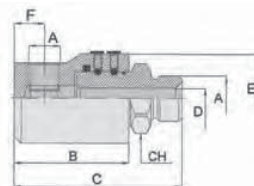

≥ 1.1/4"

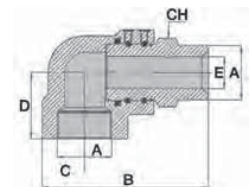

CODE CODICE	Ø A*	B		C		D		Ø E		F		CH		MAX PRESSURE IN ROTATION		STATIC MAX PRESSURE	
		mm		mm		mm		mm		mm		mm		bar	psi	bar	psi
SJ90-04	1/4"	50		69		6		33.5		11		ES19		200	2900	400	5800
SJ90-06	3/8"	54		76		8.5		37.5		13		ES24		200	2900	400	5800
SJ90-08	1/2"	63		87		11.5		39.5		14		ES27		150	2175	300	4350
SJ90-12	3/4"	74		104		15		54.5		19.5		ES34		150	2175	300	4350
SJ90-16	1"	87		119		20		55/60		24		ES41		100	1450	300	4350
SJ90-20	1.1/4"	119.5		32		52		28		-		50		100	1450	300	4350
SJ90-24	1.1/2"	140		37		62		35		-		55		80	1160	300	4350
SJ90-32	2"	151		42		64		44		-		65		50	725	250	3625